

# Diag Study

- Welcome to the Diag study.
- Please work as quickly and as accurately as possible.
- Click on the part that is broken.

# Mouse conditioning

○ 5.

○ 6.

○ 7.

○ 3.

○ 2.

○ 8.

○ 10.

○ 1.

○ 9.

○ 4.

Use the mouse to click on the numbers in the right order  
from 1 to 10

When you are ready for the next problem press on the page down button, then on the broken part, and return the mouse pointer into the circle.

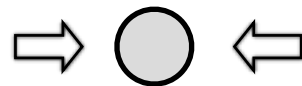

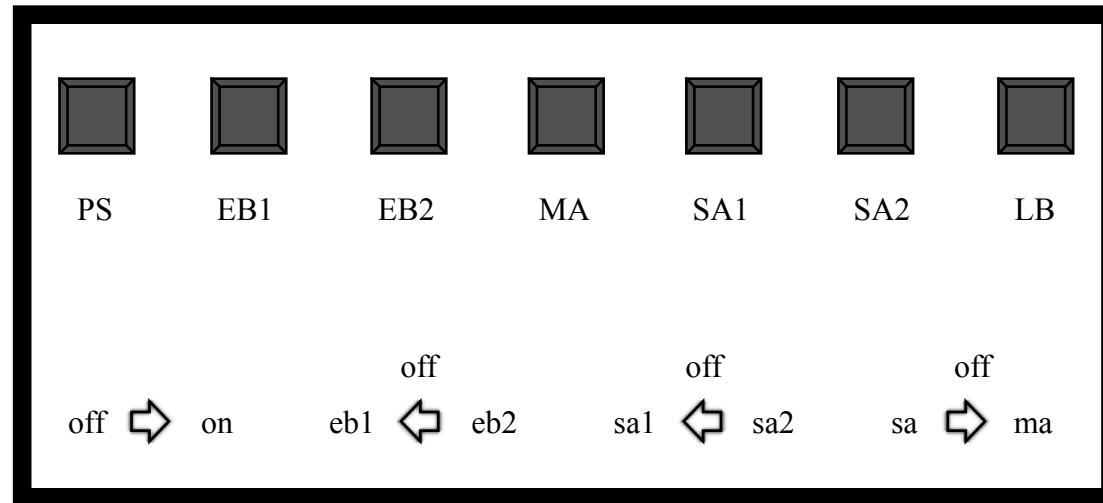

Click on the part that is broken

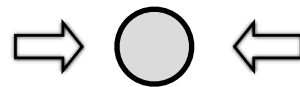

and return the mouse pointer into the circle and press the page down button again.

When you are ready for the next problem press on the page down button, then on the broken part, and return the mouse pointer into the circle.

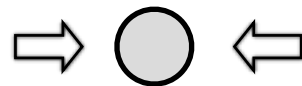

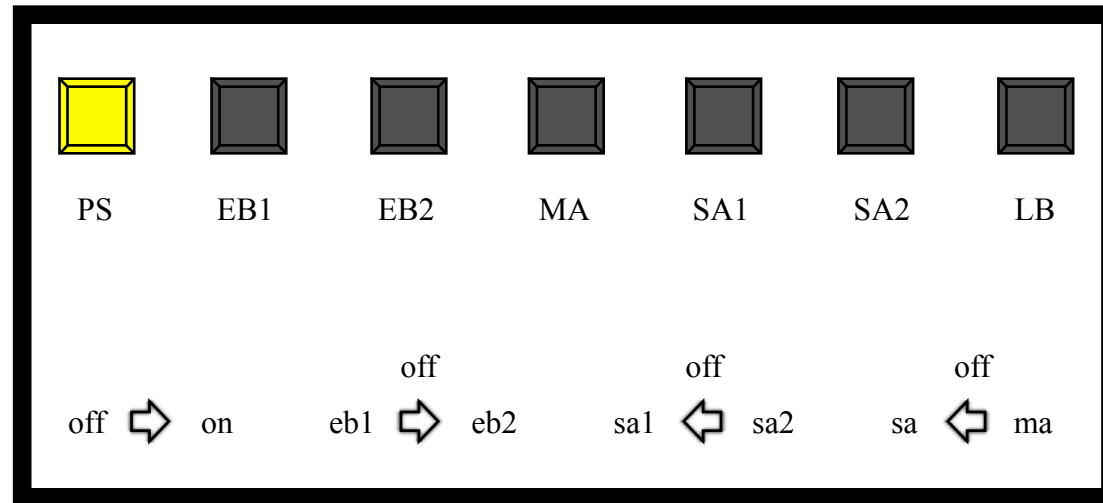

Click on the part that is broken

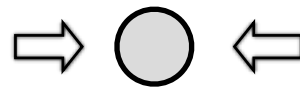

and return the mouse pointer into the circle and press the page down button again.

When you are ready for the next problem press on the page down button, then on the broken part, and return the mouse pointer into the circle.

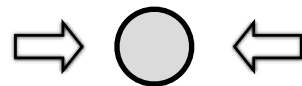

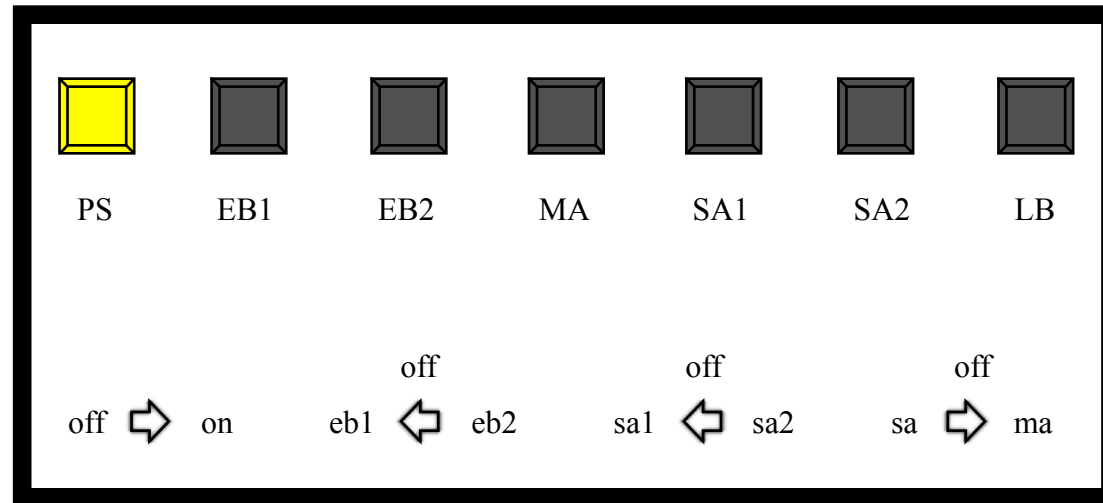

Click on the part that is broken

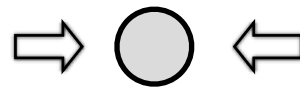

and return the mouse pointer into the circle and press the page down button again.



When you are ready for the next problem press on the page down button, then on the broken part, and return the mouse pointer into the circle.

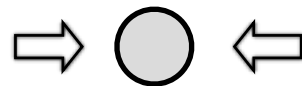

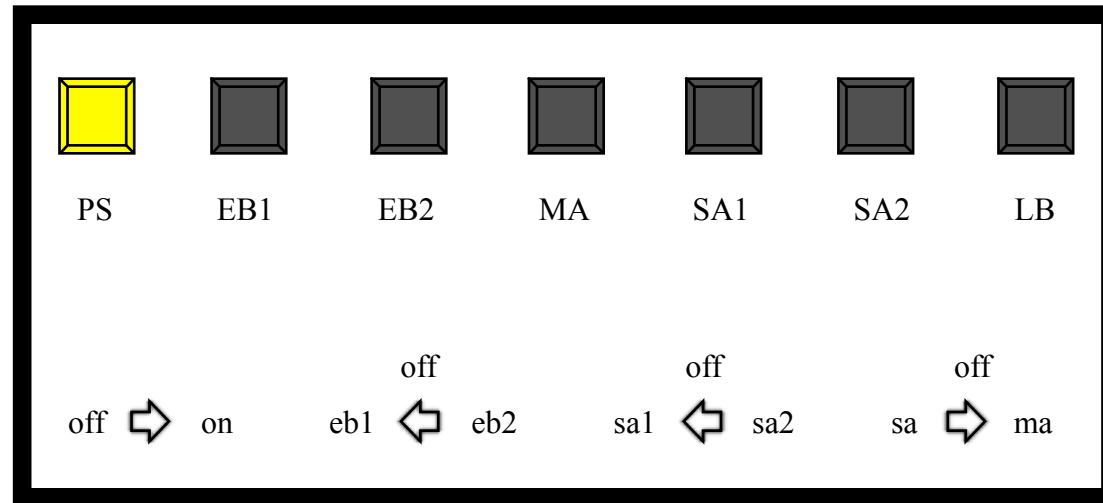

# Click on the part that is broken

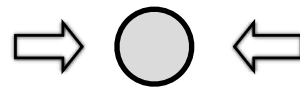

and return the mouse pointer into the circle and press the page down button again.

When you are ready for the next problem press on the page down button, then on the broken part, and return the mouse pointer into the circle.

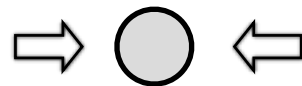

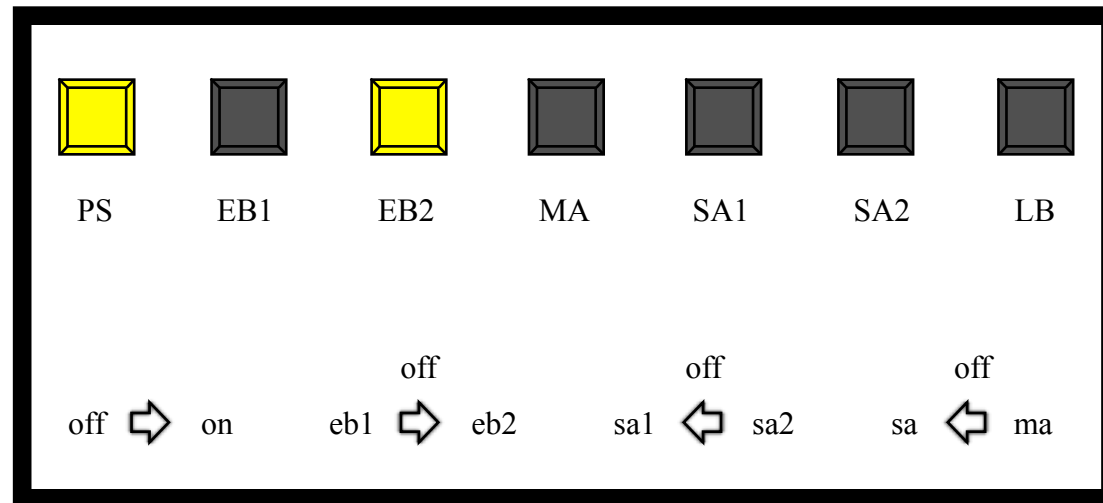

Click on the part that is broken

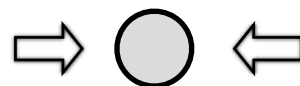

and return the mouse pointer into the circle and press the page down button again.

When you are ready for the next problem press on the page down button, then on the broken part, and return the mouse pointer into the circle.

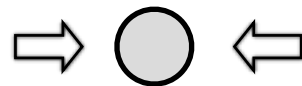

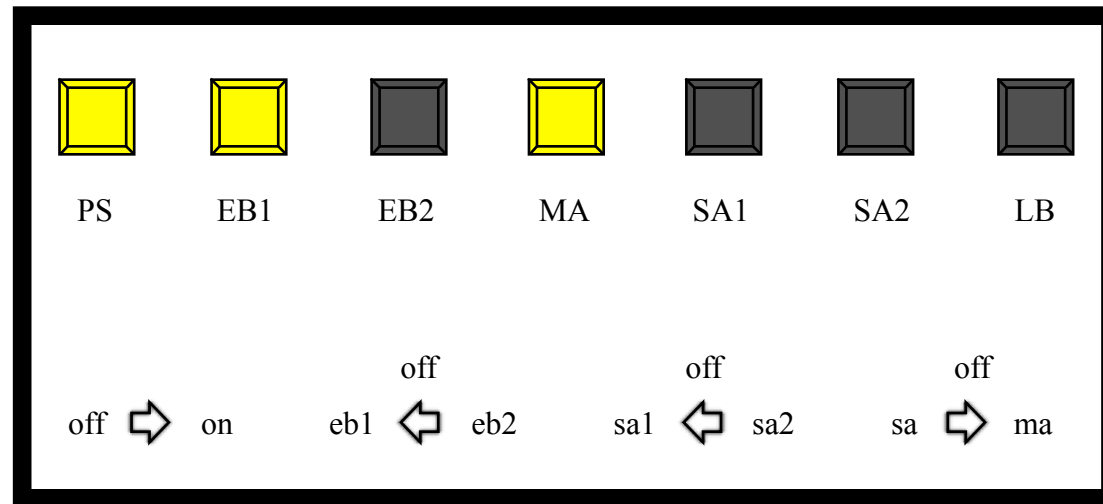

Click on the part that is broken

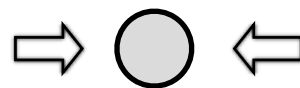

and return the mouse pointer into the circle and press the page down button again.

When you are ready for the next problem press on the page down button, then on the broken part, and return the mouse pointer into the circle.

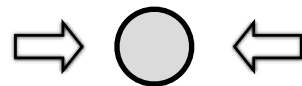

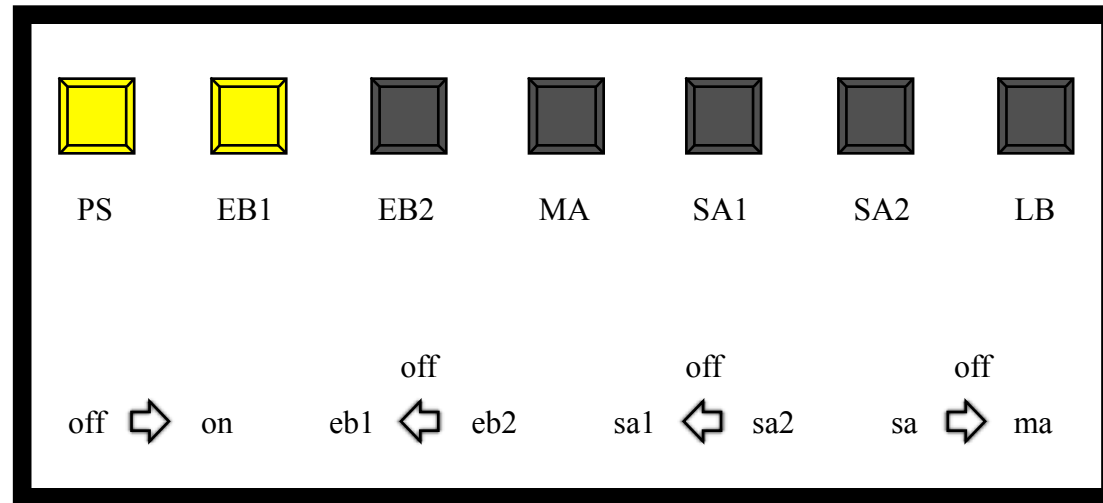

# Click on the part that is broken

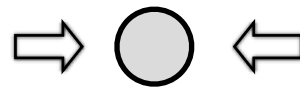

and return the mouse pointer into the circle and press the page down button again.



When you are ready for the next problem press on the page down button, then on the broken part, and return the mouse pointer into the circle.

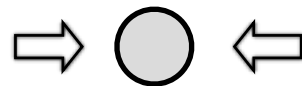

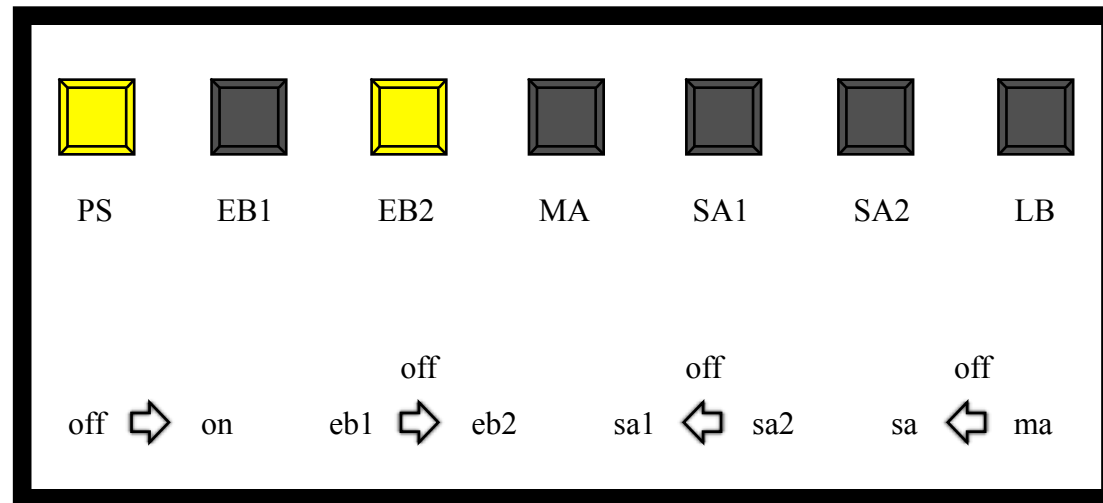

Click on the part that is broken

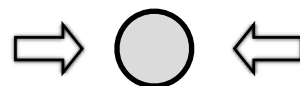

and return the mouse pointer into the circle and press the page down button again.

When you are ready for the next problem press on the page down button, then on the broken part, and return the mouse pointer into the circle.

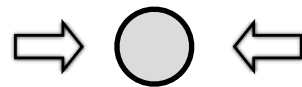

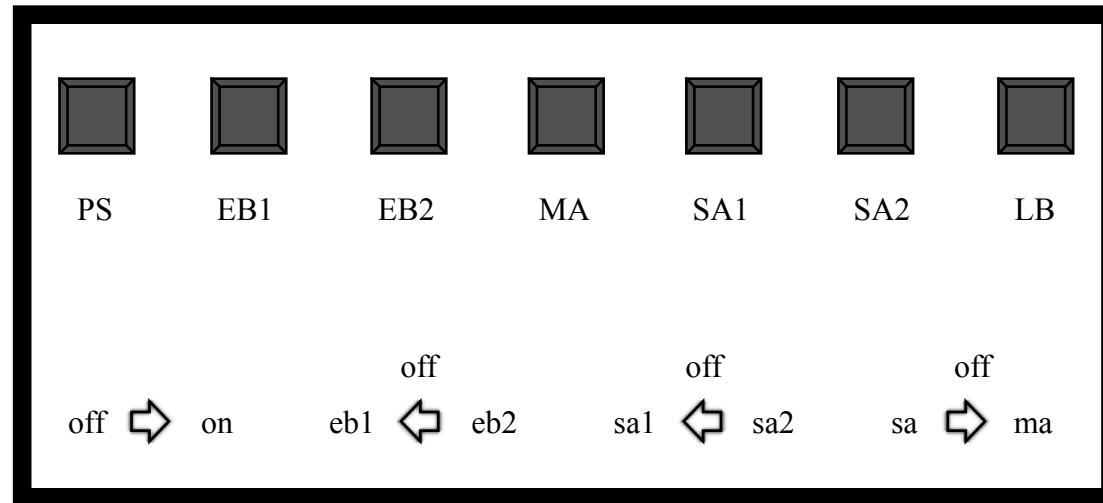

# Click on the part that is broken

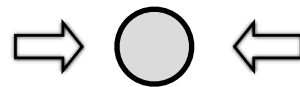

and return the mouse pointer into the circle and press the page down button again.

When you are ready for the next problem press on the page down button, then on the broken part, and return the mouse pointer into the circle.

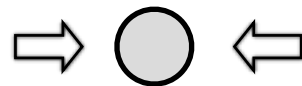

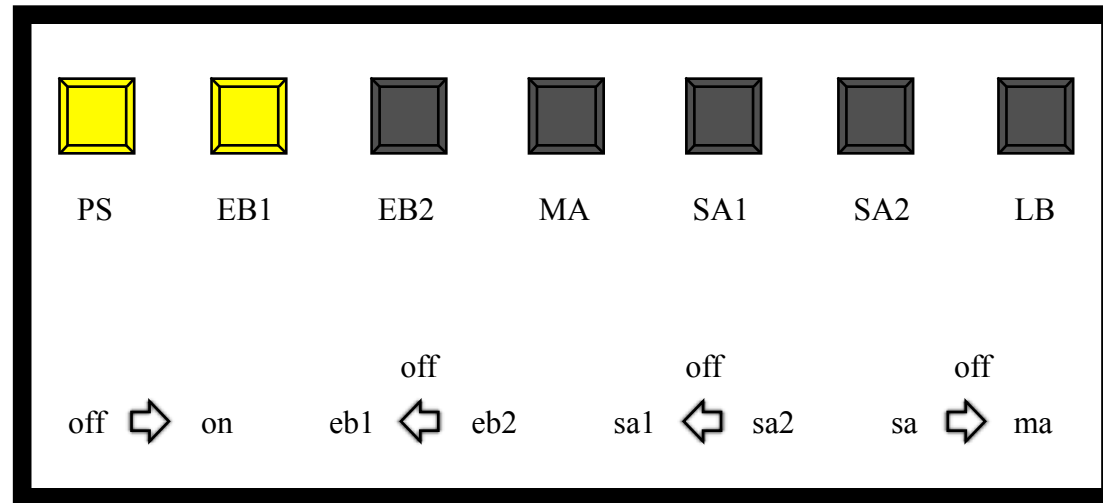

Click on the part that is broken

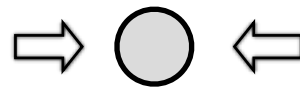

and return the mouse pointer into the circle and press the page down button again.

When you are ready for the next problem press on the page down button, then on the broken part, and return the mouse pointer into the circle.

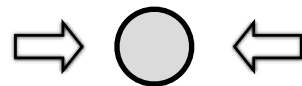

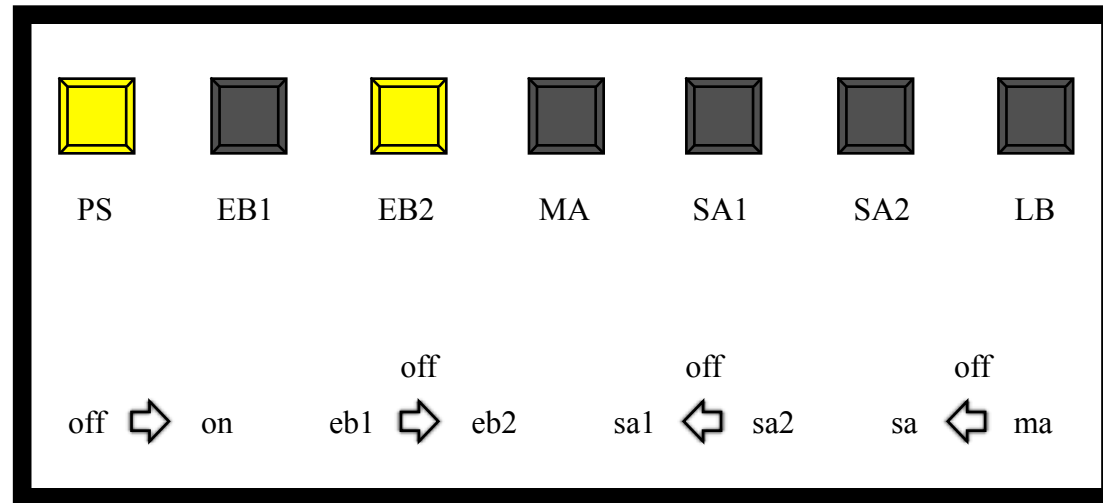

Click on the part that is broken

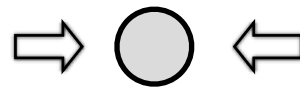

and return the mouse pointer into the circle and press the page down button again.



When you are ready for the next problem press on the page down button, then on the broken part, and return the mouse pointer into the circle.

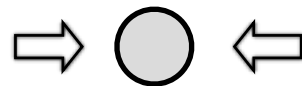

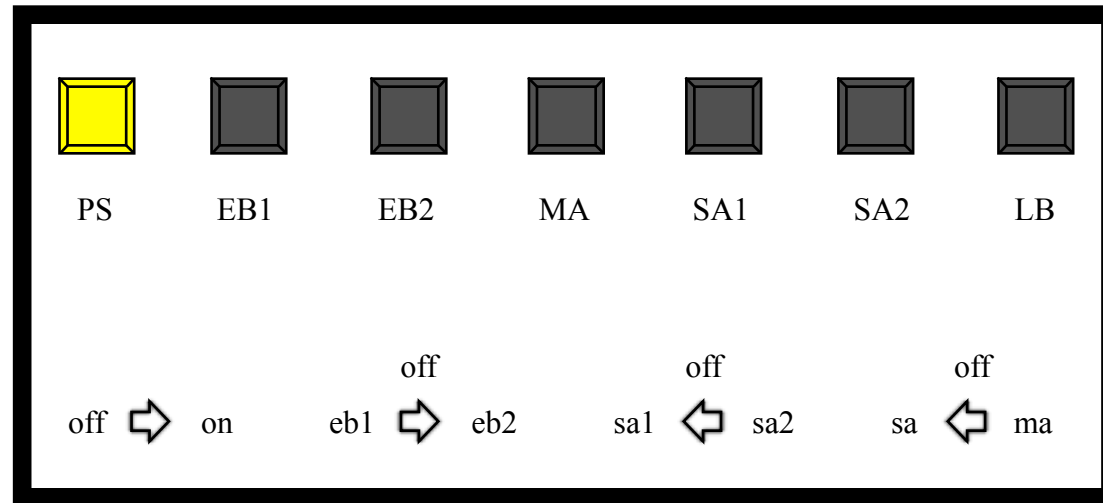

# Click on the part that is broken

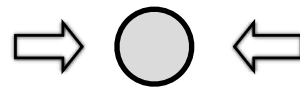

and return the mouse pointer into the circle and press the page down button again.

When you are ready for the next problem press on the page down button, then on the broken part, and return the mouse pointer into the circle.

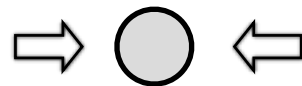

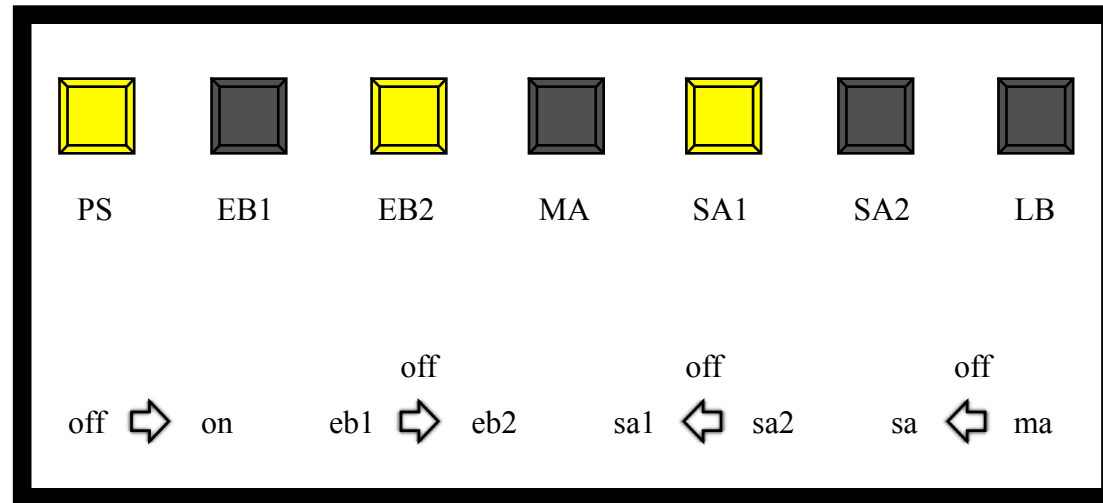

Click on the part that is broken

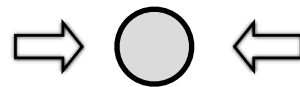

and return the mouse pointer into the circle and press the page down button again.

When you are ready for the next problem press on the page down button, then on the broken part, and return the mouse pointer into the circle.

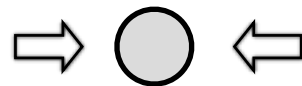

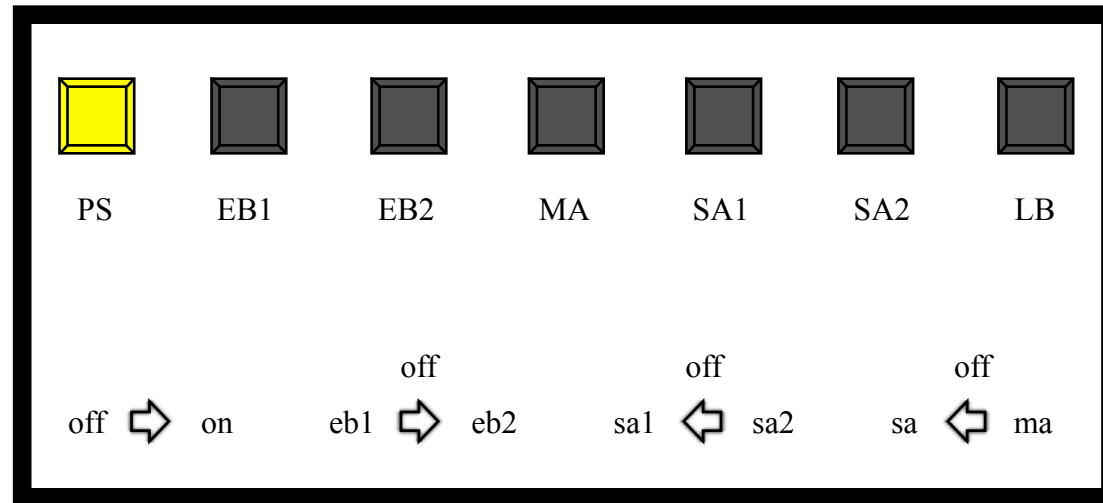

Click on the part that is broken

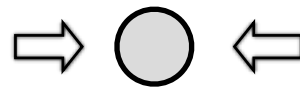

and return the mouse pointer into the circle and press the page down button again.

When you are ready for the next problem press on the page down button, then on the broken part, and return the mouse pointer into the circle.

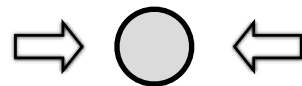

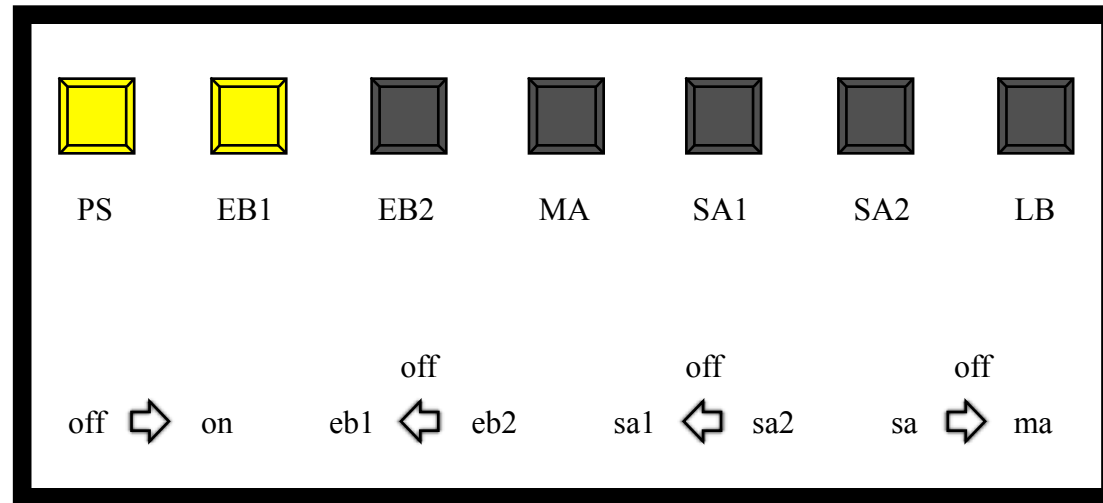

# Click on the part that is broken

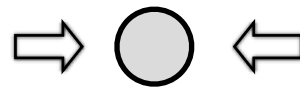

and return the mouse pointer into the circle and press the page down button again.



When you are ready for the next problem press on the page down button, then on the broken part, and return the mouse pointer into the circle.

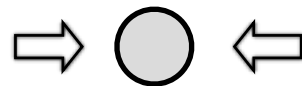

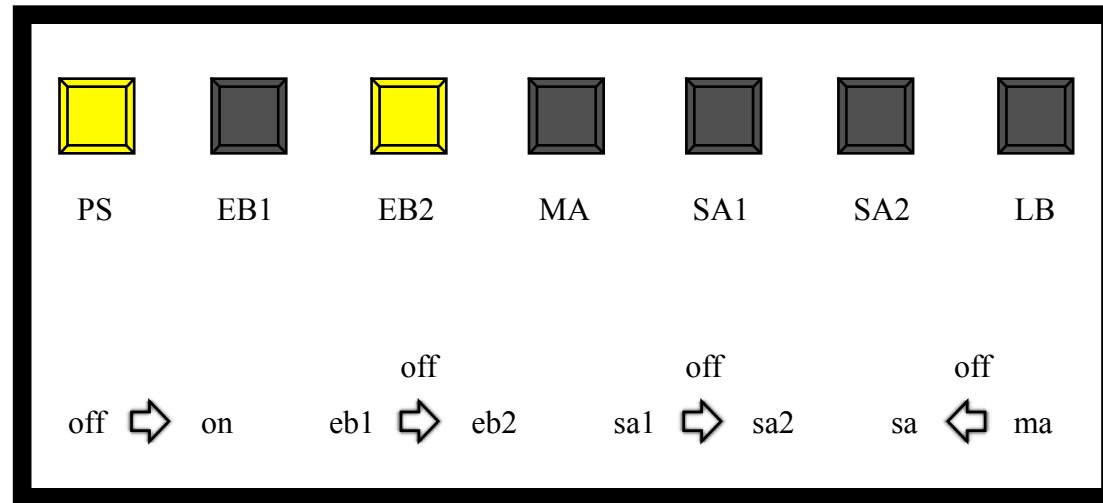

Click on the part that is broken

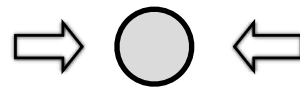

and return the mouse pointer into the circle and press the page down button again.

When you are ready for the next problem press on the page down button, then on the broken part, and return the mouse pointer into the circle.

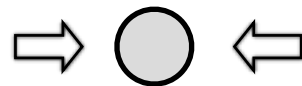

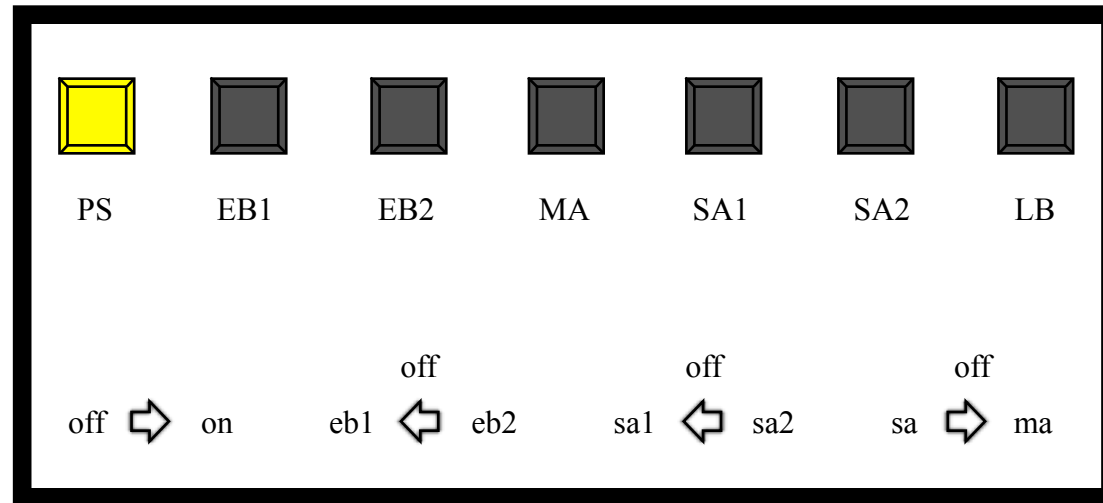

Click on the part that is broken

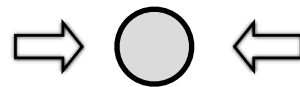

and return the mouse pointer into the circle and press the page down button again.

When you are ready for the next problem press on the page down button, then on the broken part, and return the mouse pointer into the circle.

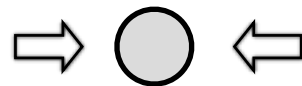

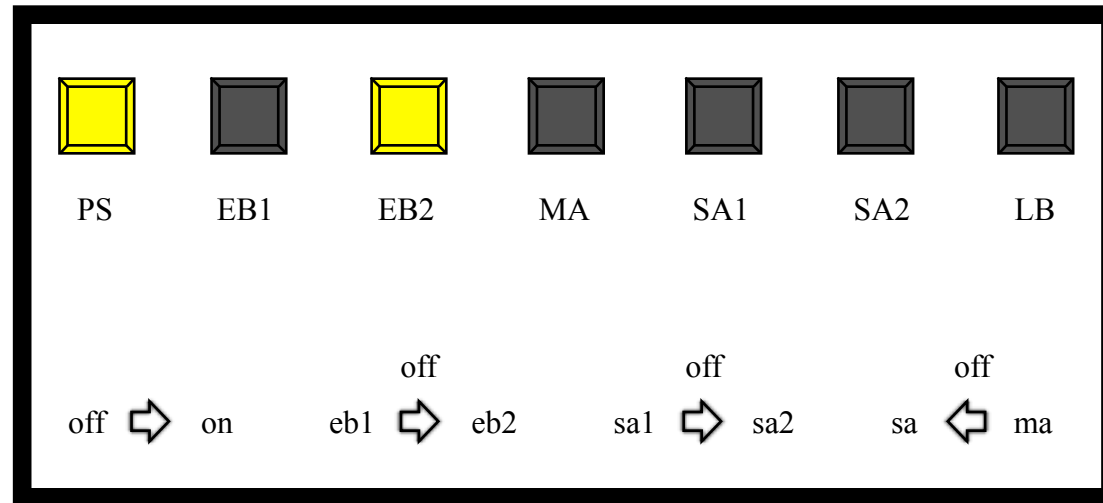

Click on the part that is broken

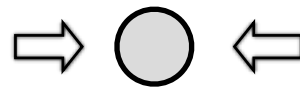

and return the mouse pointer into the circle and press the page down button again.

When you are ready for the next problem press on the page down button, then on the broken part, and return the mouse pointer into the circle.

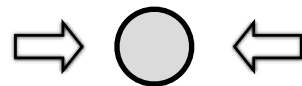

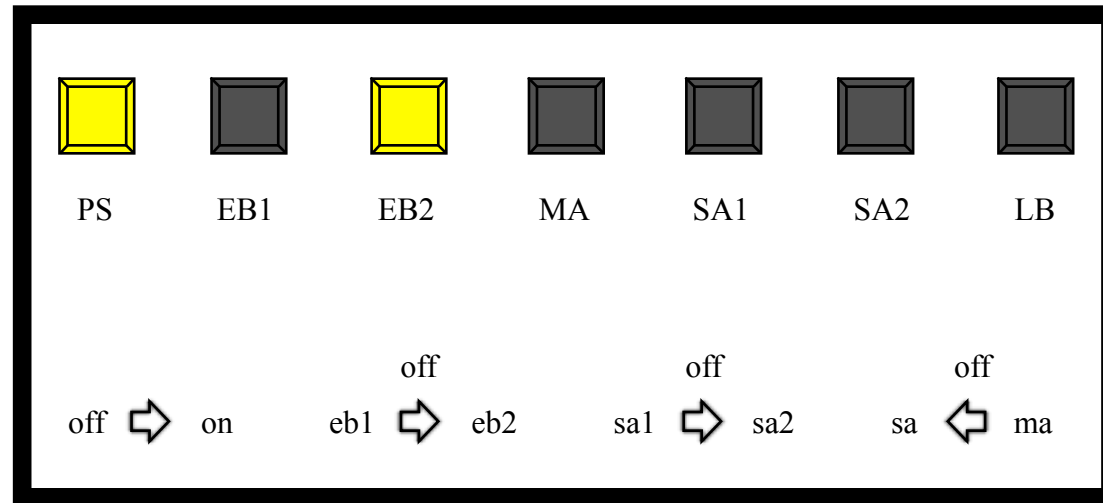

Click on the part that is broken

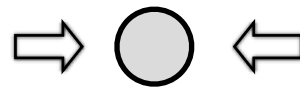

and return the mouse pointer into the circle and press the page down button again.



When you are ready for the next problem press on the page down button, then on the broken part, and return the mouse pointer into the circle.

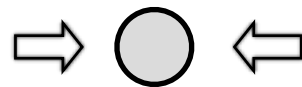

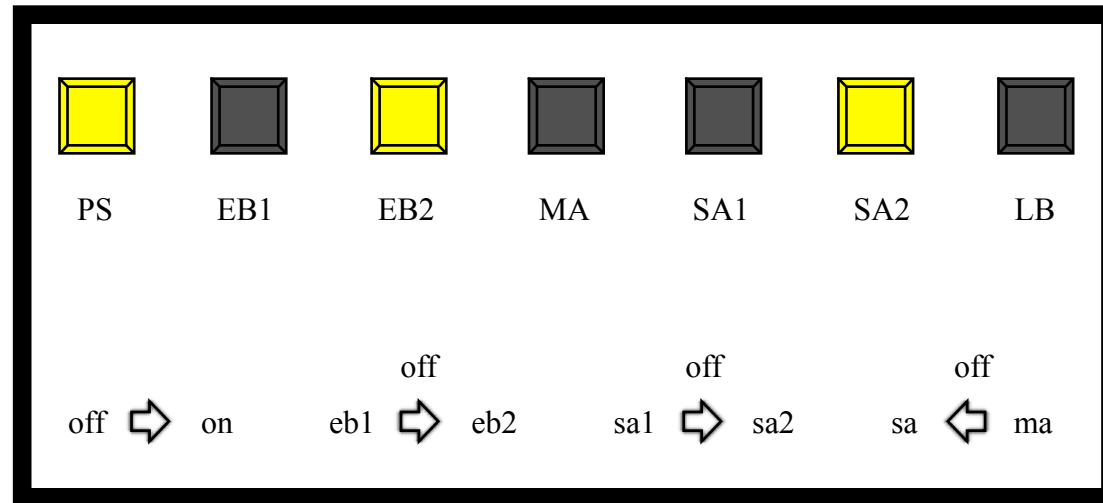

Click on the part that is broken

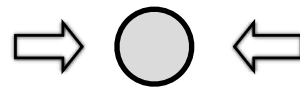

and return the mouse pointer into the circle and press the page down button again.

Thank you for your  
participation.